

CHARACTERISTICS

Nominal Voltage		12V
Nominal Capacity (20 hour rate)		220Ah
Capacity 25°C	10 hour rate (9.0A)	198Ah
	5 hour rate (15.9A)	165Ah
	1 hour rate (55.4A)	122.2Ah
Internal Resistance	Full Charged Battery 25°C	≤2.7mΩ
Capacity affected by Temperature (10 hour)	40°C	102%
	25°C	100%
	0°C	85%
	-15°C	65%
Self-Discharge 25°C Capacity	after 3 month storage	90%
	after 6 month storage	80%
	after 12 month storage	62%
Charge (Constant Voltage) 25°C	Float	Initial Charging Current Less than 44A Voltage 13.6-13.8V
	Cycle	Initial Charging Current Less than 44A Voltage 14.4-14.9V



PACKAGING

Battery Dimensions	Length	522mm
	Width	240mm
	Height	219mm
	Total Height	225mm
Box Dimensions	Length	537mm
	Width	255mm
	Height	299mm
Quantity Per Box	1 PC per box	
Net weight Per Cell	65kg±3%	
Net weight Per Box	65kg	
Gross Weight	66kg	

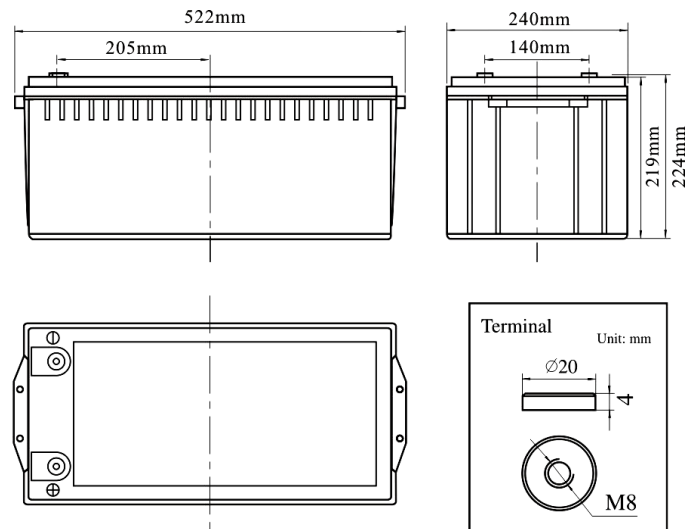

Discharge Constant Current per Cell (Amperes at 25°C)

F.V/Time	5min	10min	15min	30min	45min	1h	2h	3h	5h	8h	10h	20h
1.60V	283.1	180.3	133.1	122.2	77.6	54.5	37.0	24.4	21.8	11.9	11.9	2.64
1.65V	278.0	177.0	130.7	120.0	76.2	53.5	36.4	24.0	21.4	11.7	11.6	2.59
1.70V	272.8	173.7	128.3	117.8	74.7	52.5	35.7	23.6	21.0	11.4	11.4	2.54
1.75V	267.7	170.5	125.8	115.5	73.3	51.5	35.0	23.1	20.6	11.2	11.2	2.49
1.80V	257.4	163.9	121.0	111.1	70.5	49.5	33.7	22.2	19.8	11.0	10.8	2.44

Discharge Constant Current per Cell (Watts at 25°C)

F.V/Time	5min	10min	15min	30min	45min	1h	2h	3h	5h	8h	10h	20h
1.60V	545.0	347.1	256.2	235.3	149.3	104.8	71.3	47.1	41.9	22.9	22.8	5.08
1.65V	535.1	340.7	251.6	231.0	146.6	102.9	70.0	46.2	41.2	22.4	22.4	4.98
1.70V	525.2	334.4	246.9	226.7	143.9	101.0	68.7	45.3	40.4	22.0	22.0	4.89
1.75V	515.3	328.1	242.2	222.4	141.2	99.1	67.4	44.5	39.6	21.6	21.6	4.79
1.80V	495.5	315.5	232.9	213.9	135.7	95.3	64.8	42.8	38.1	21.2	20.8	4.70

Note: The above data are average values, and can be obtained within 3 charge/discharge cycles. These are not minimum values. Cell and battery designs/specifications are subject to modification without notice. Contact R&J for the latest information.

PERFORMANCE CHARACTERISTICS

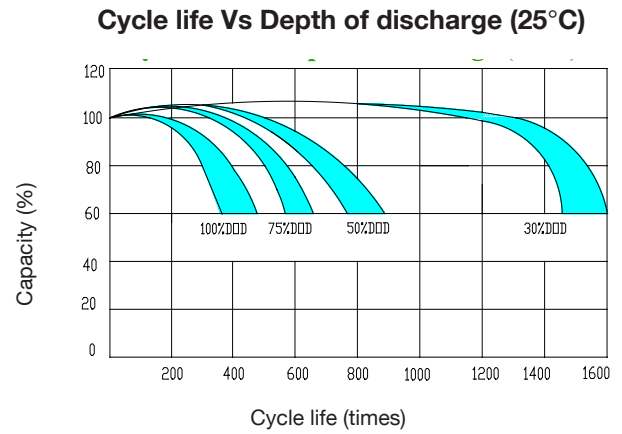
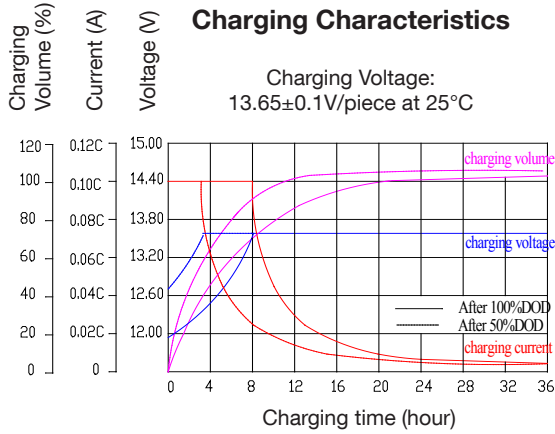

Temperature effect on designed float life

Float charging Voltage: 13.65±0.01V/piece at 25°C

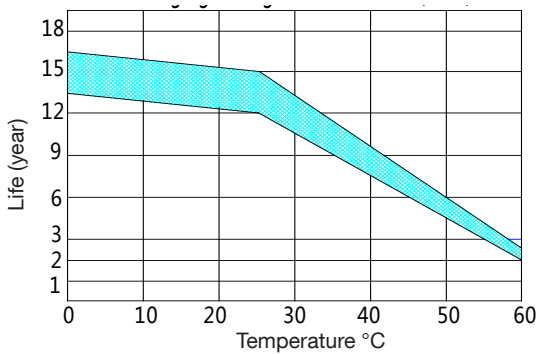

Discharge characteristics (25°C)

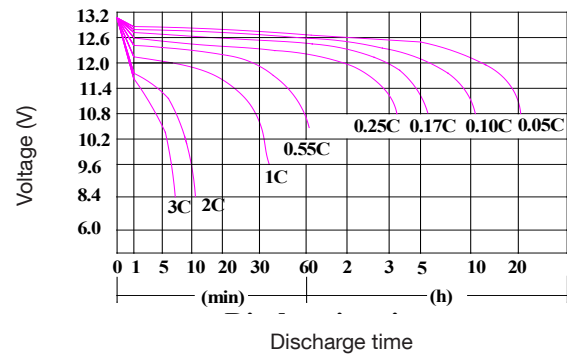

Temperature effect on battery self-discharge

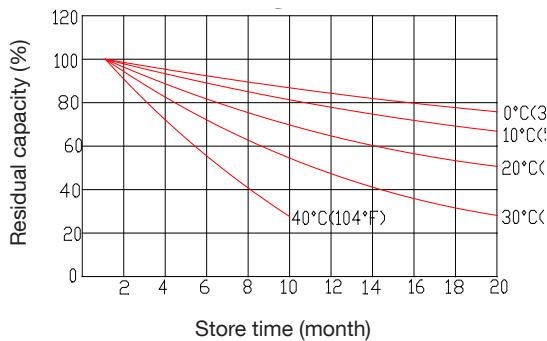

Temperature effect on capacity

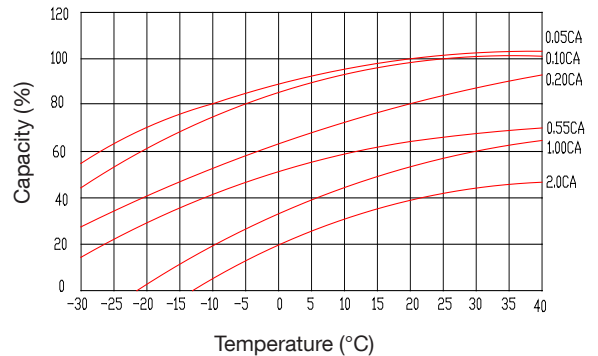

BATTERY CONSTRUCTION

Component	Positive plate	Negative plate	Container	Cover	Safety valve	Terminal	Separator	Electrolyte
Raw material	Lead dioxide	Lead	ABS	ABS	Si-Rubber	Copper	Fiberglass	Sulfuric acid